

fischer[®]technik

Ergänzung zu den Grundkästen

Statik I



Download von www.ft-fanarchiv.de
gescannt von Peter Remm















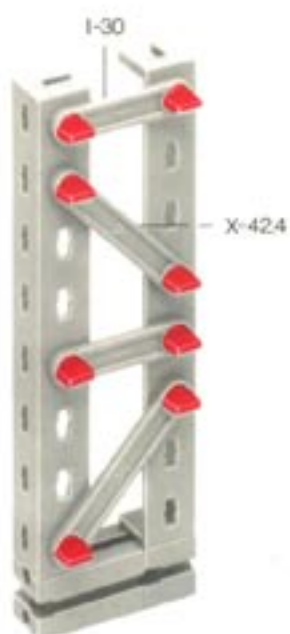

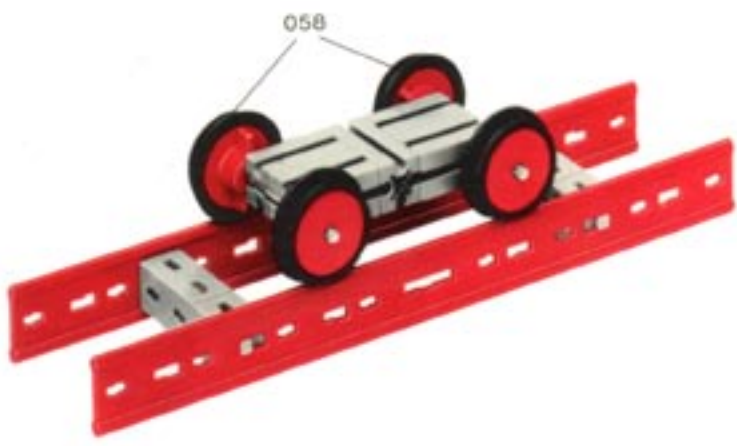
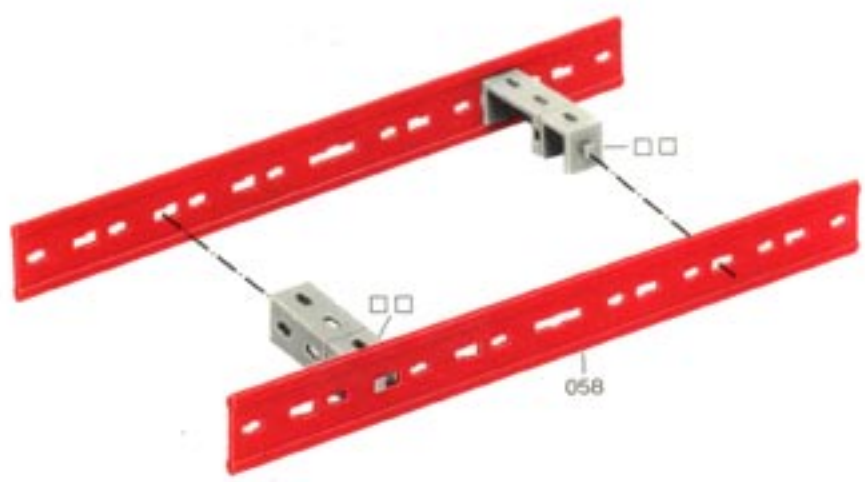



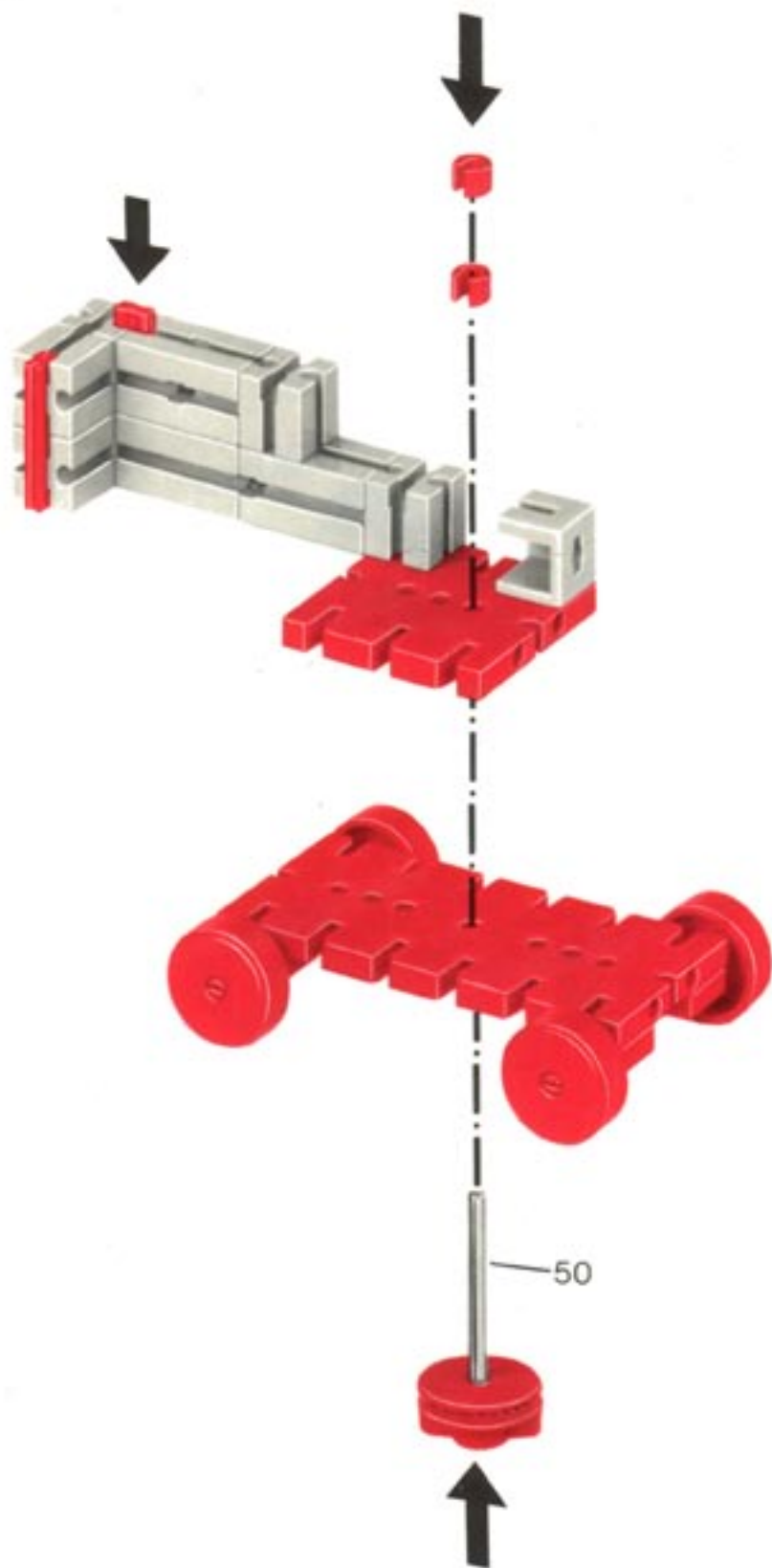

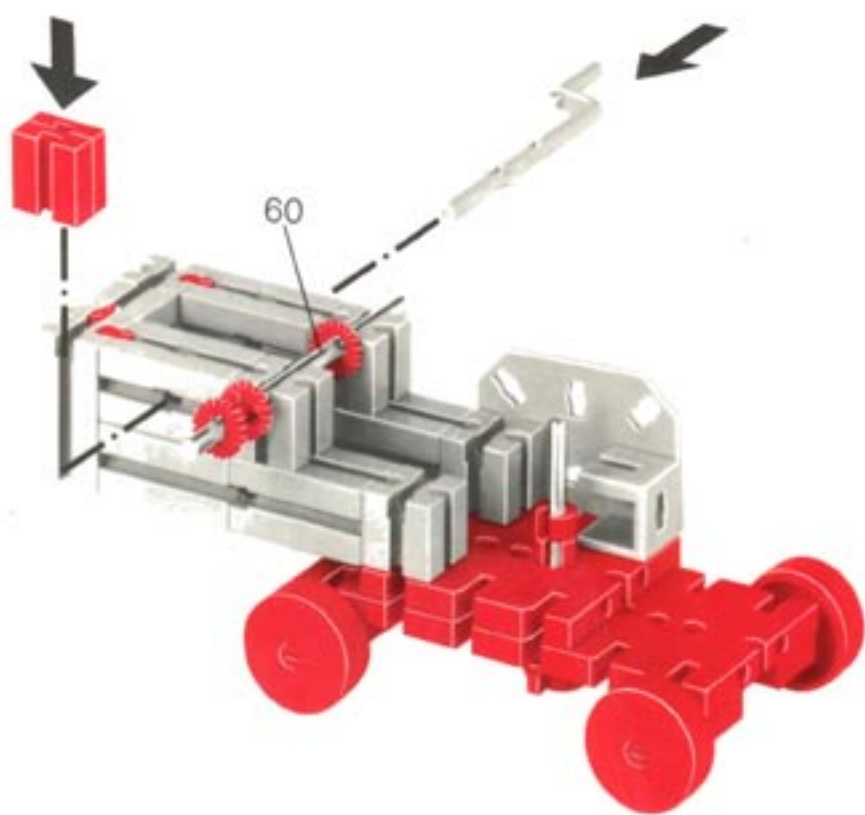

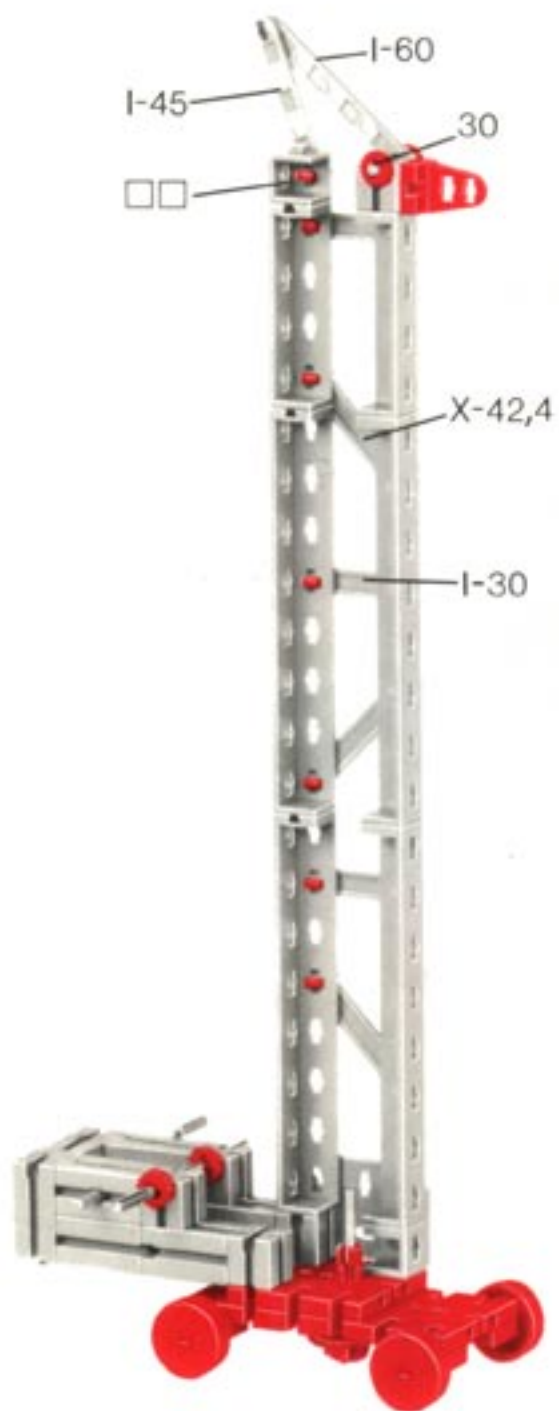

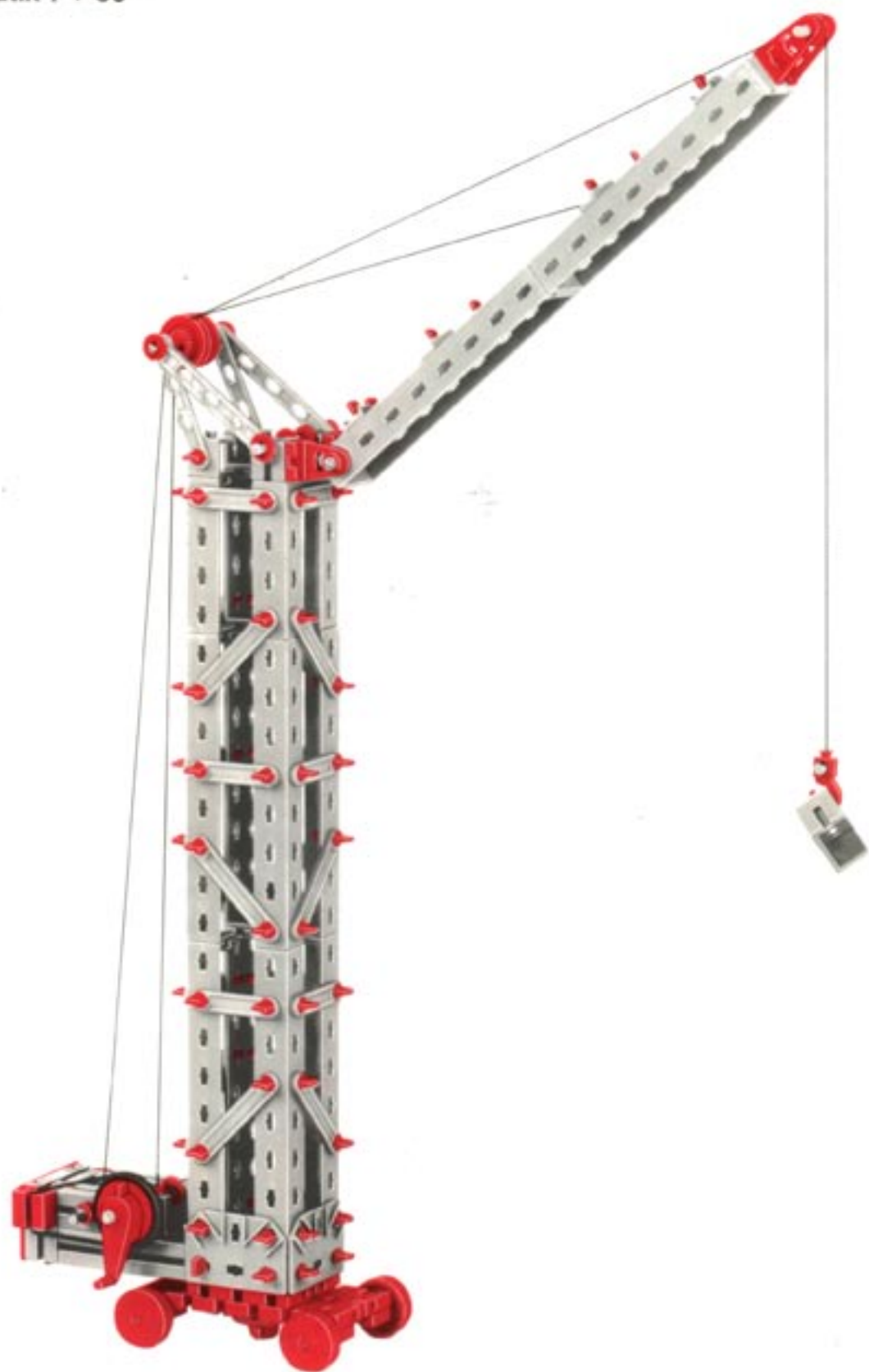

Statik 1 + 50

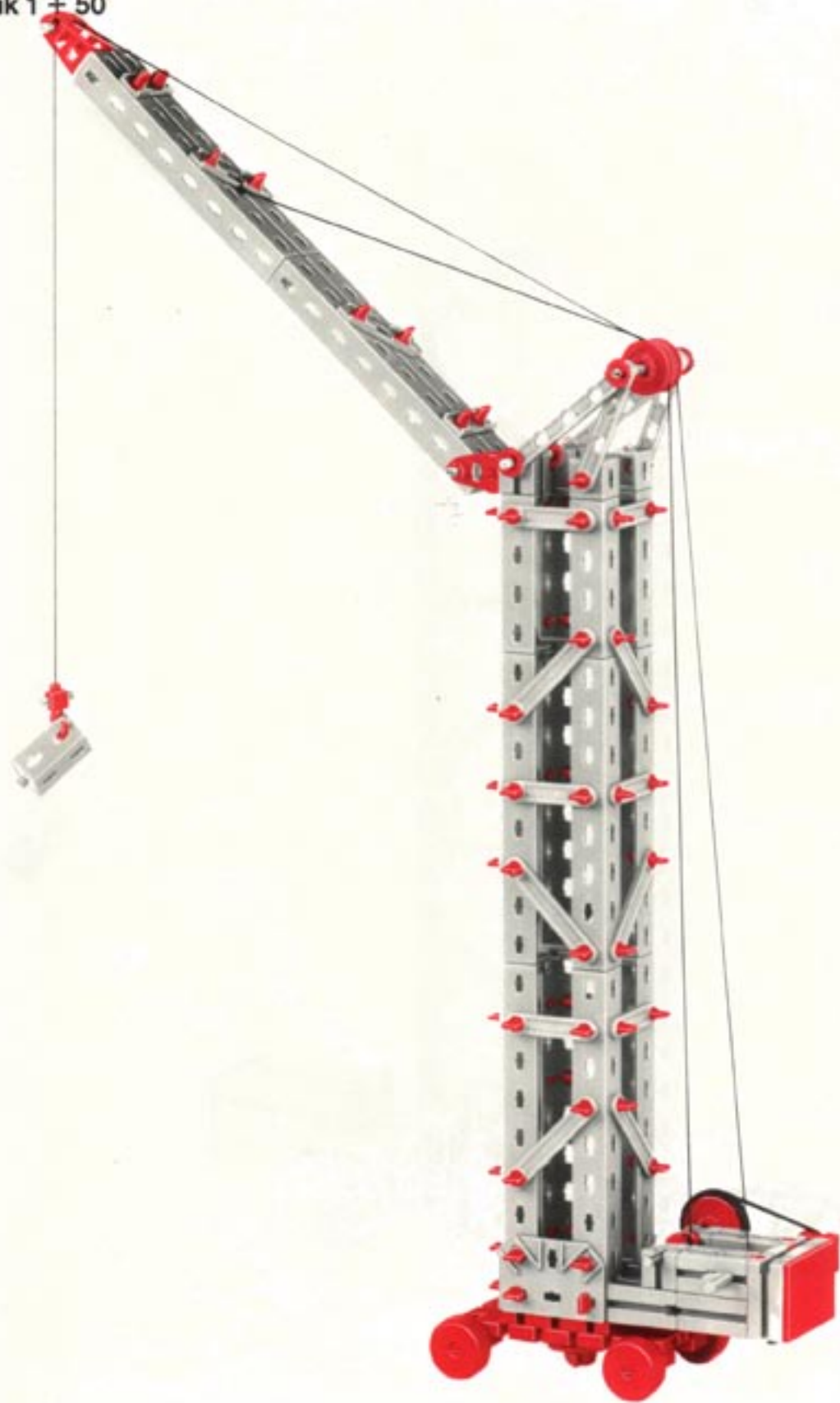



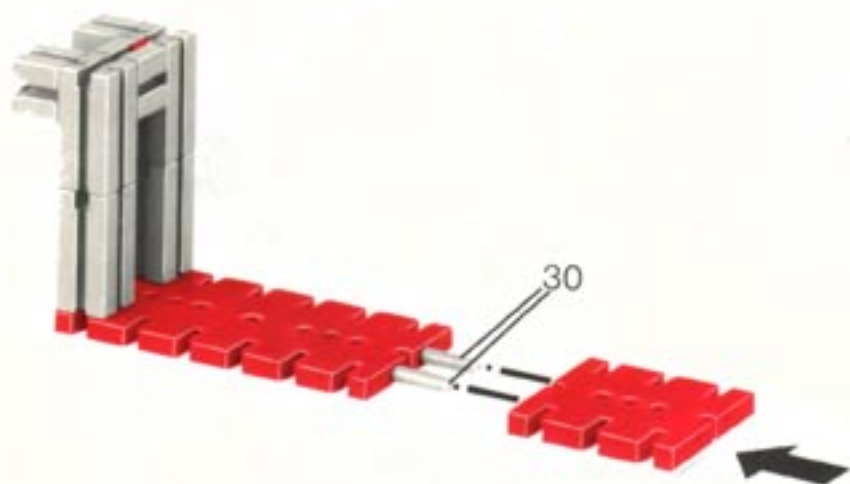

Statik 1 + 50

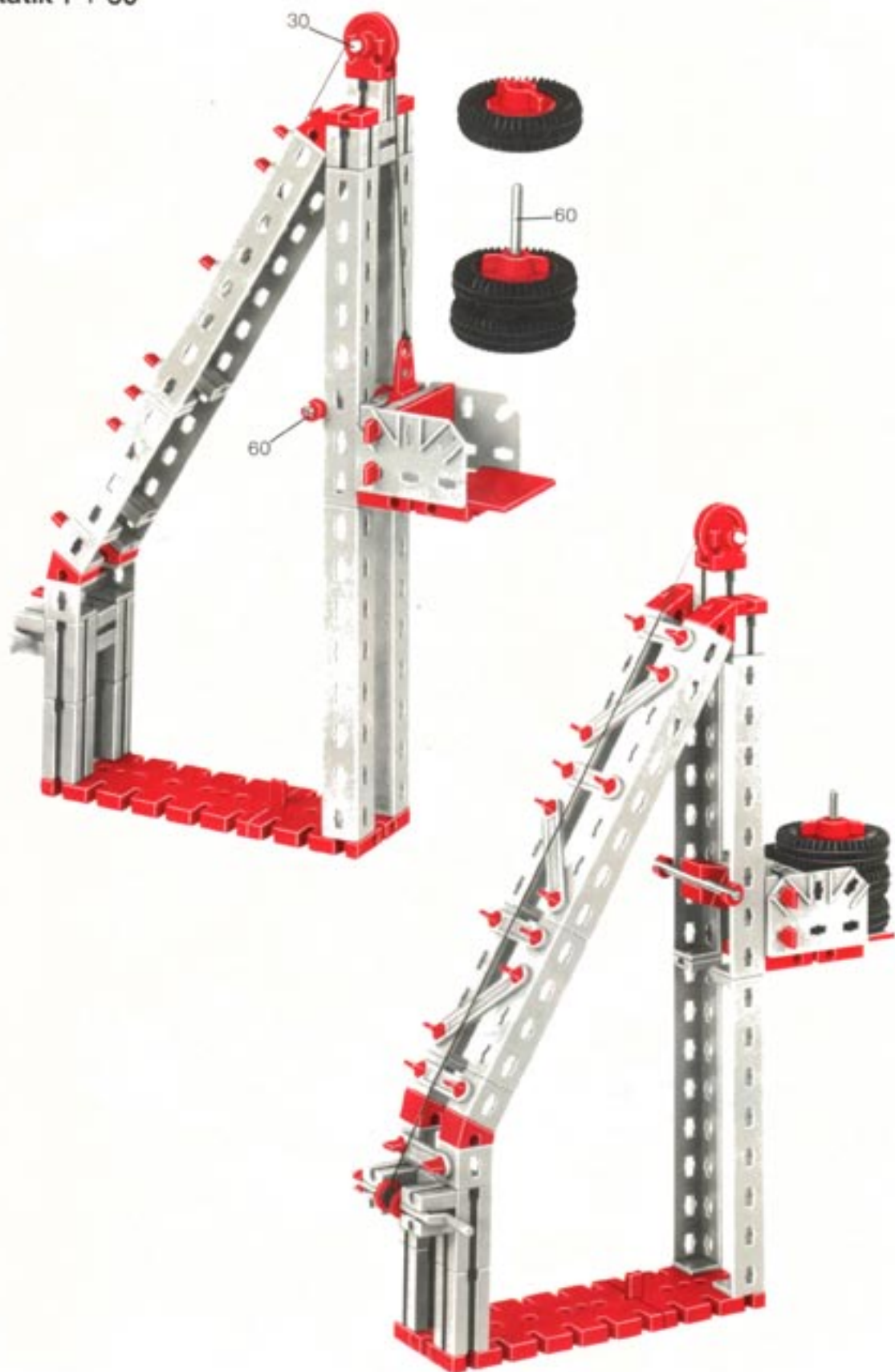

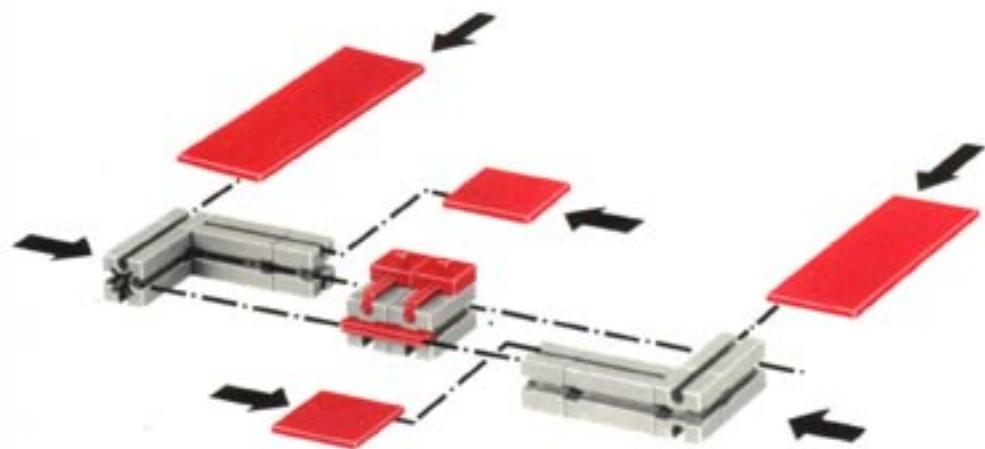



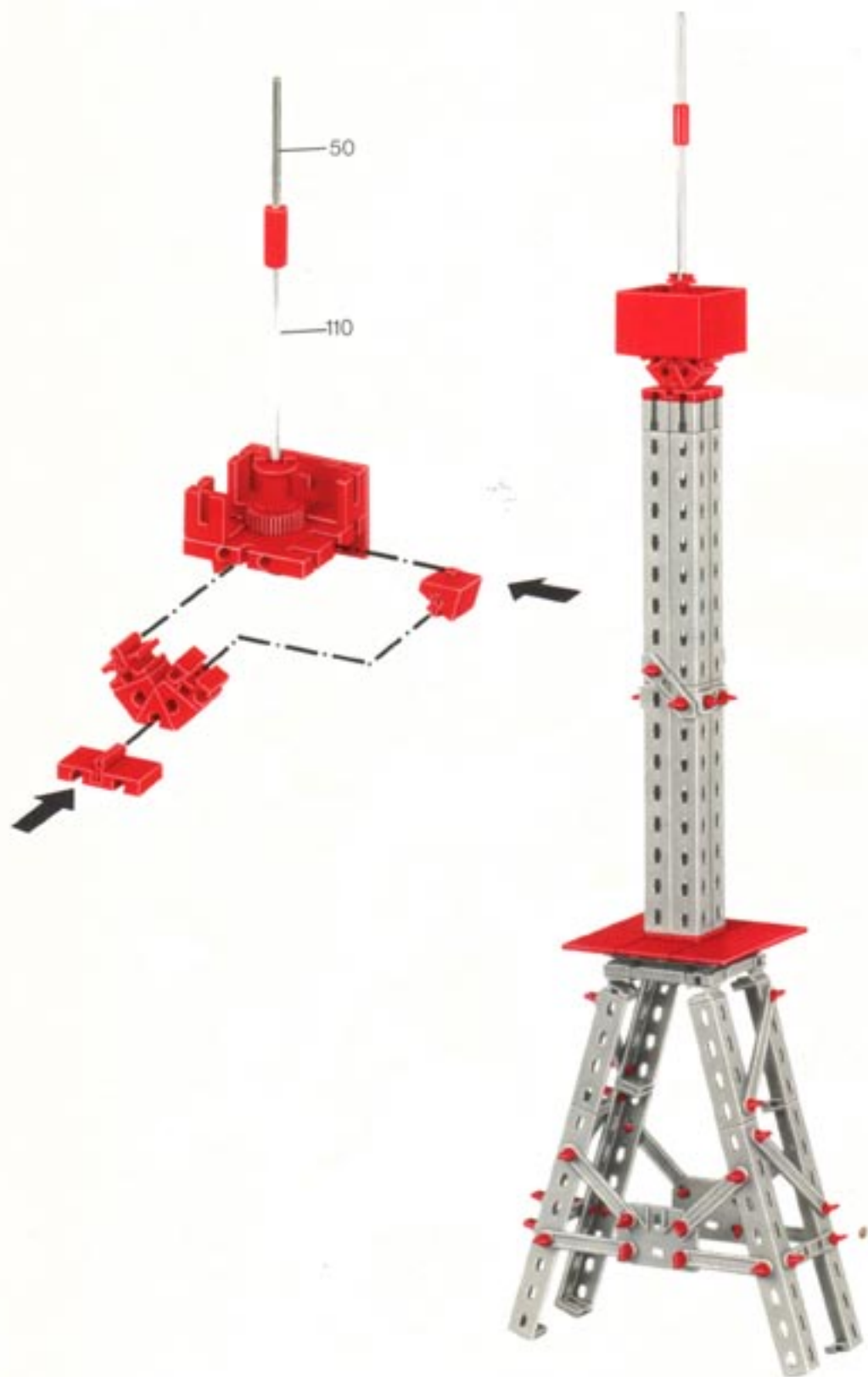

Statik 1 + 100

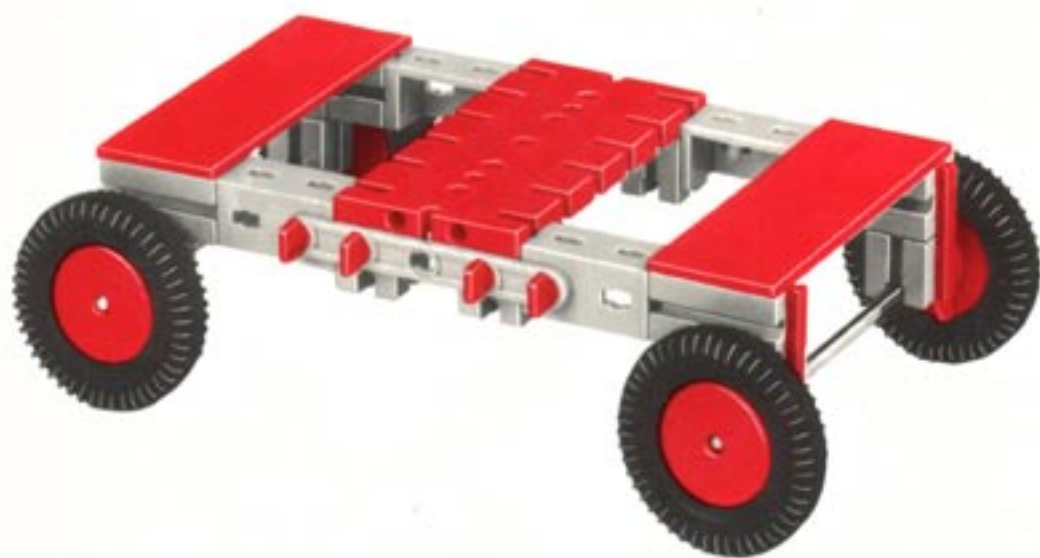
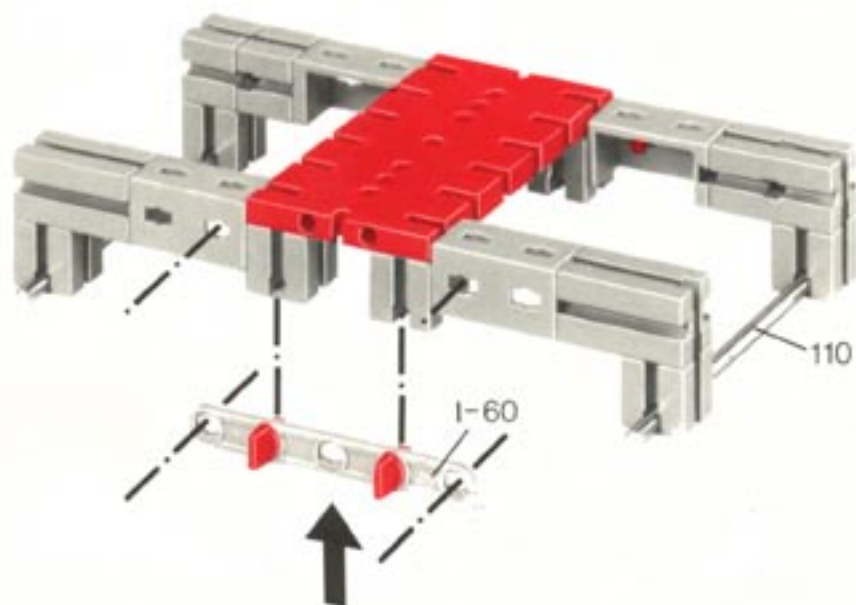

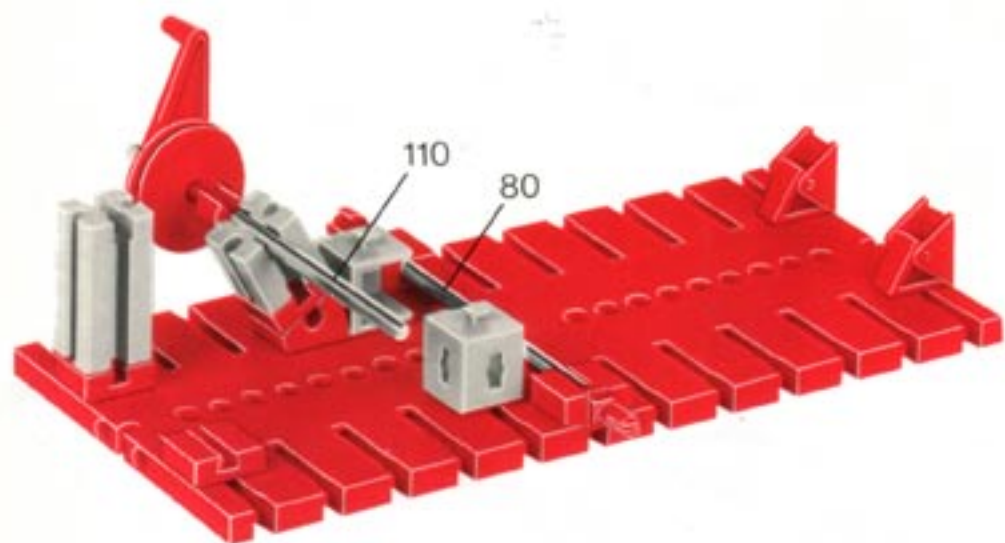

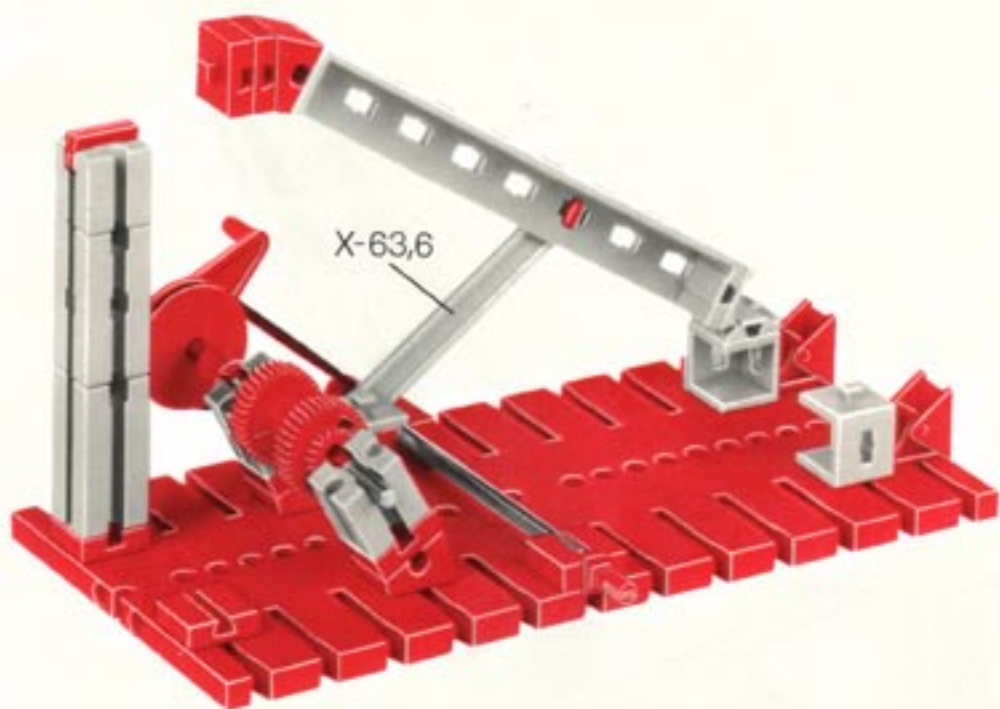

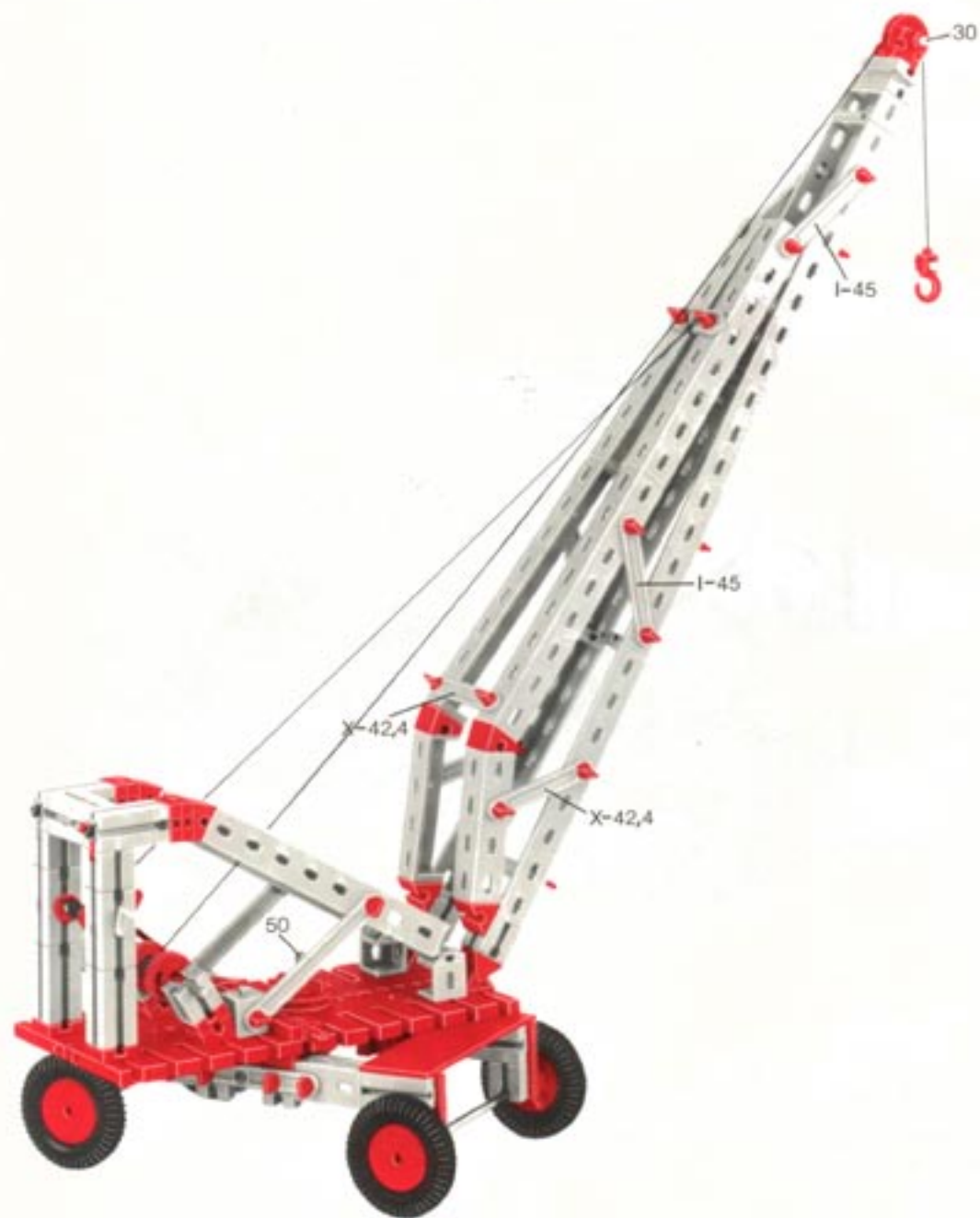



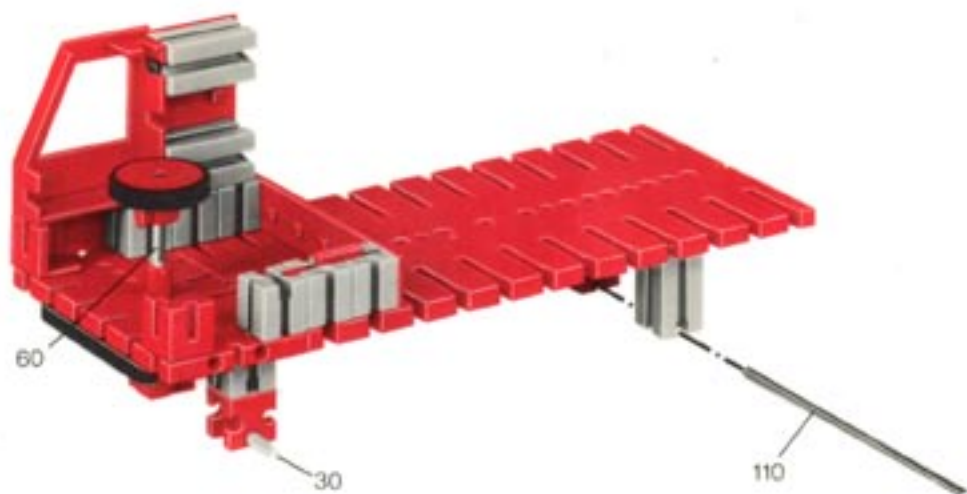
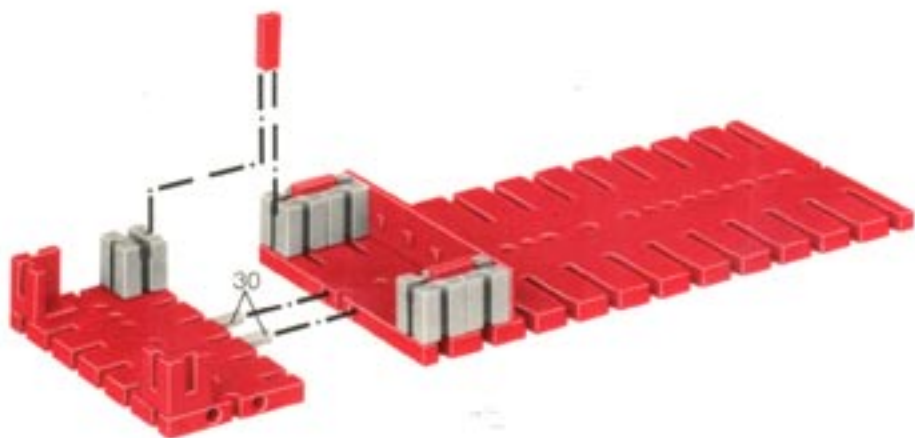











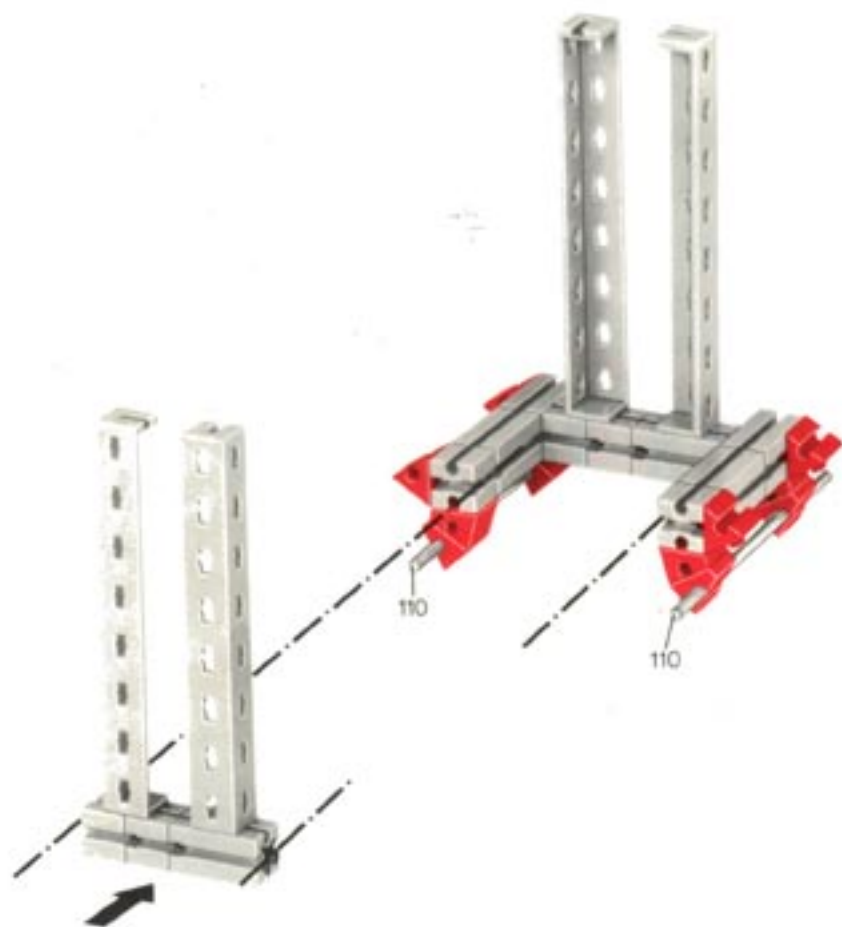





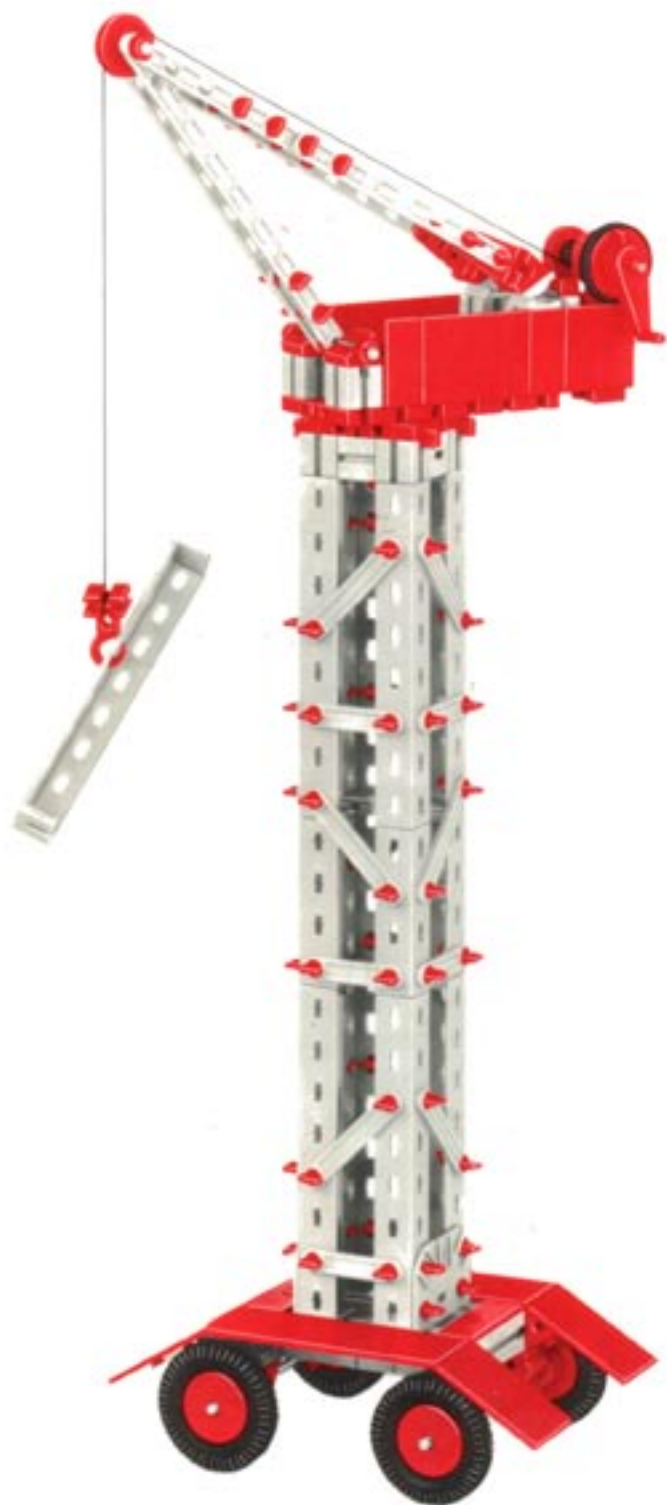

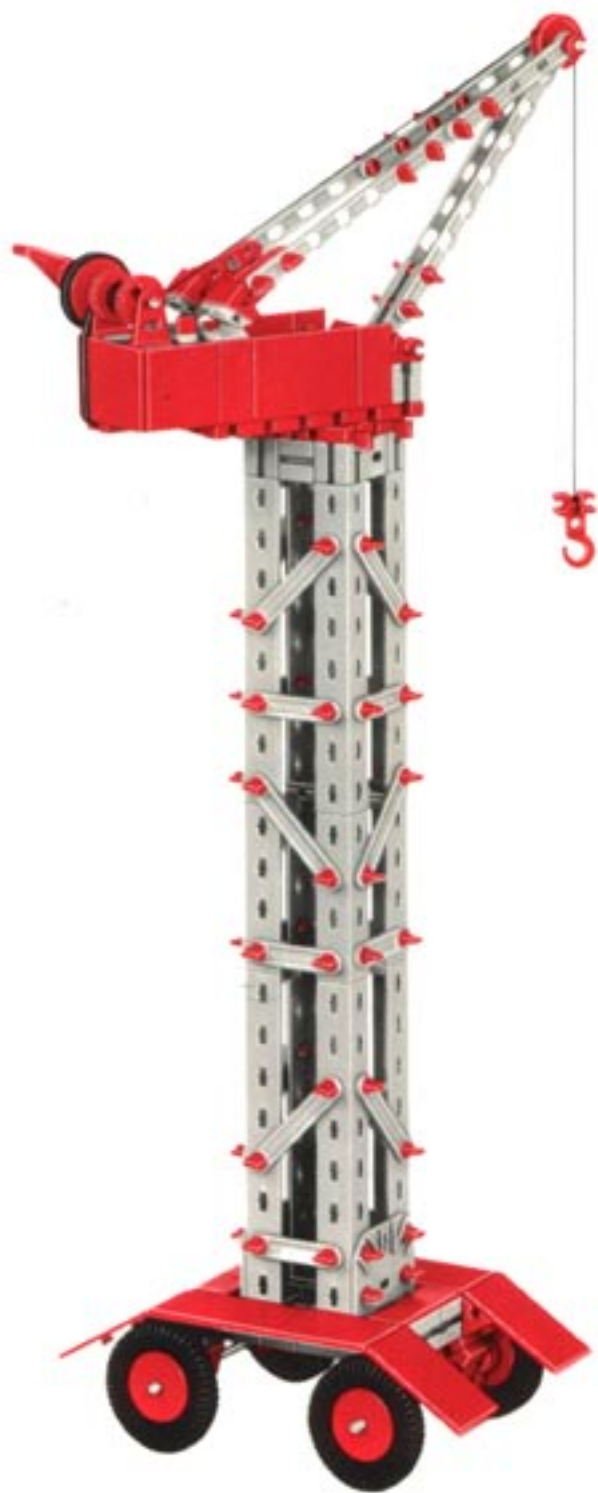

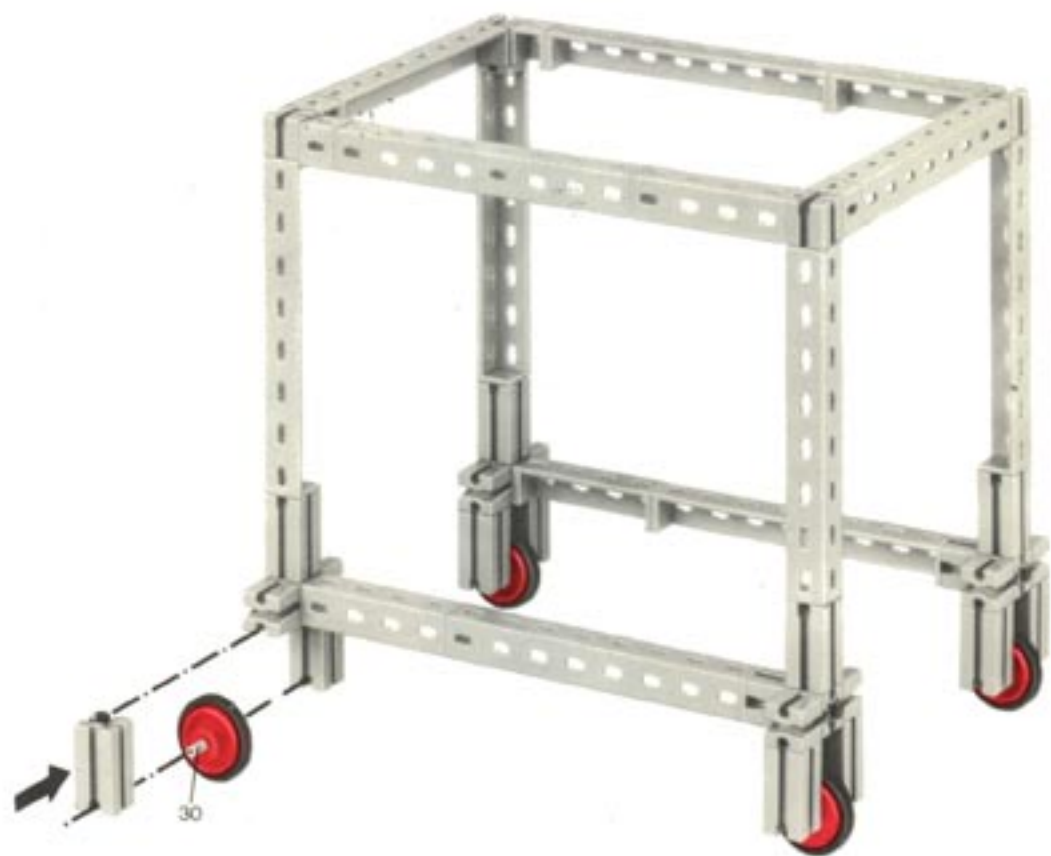

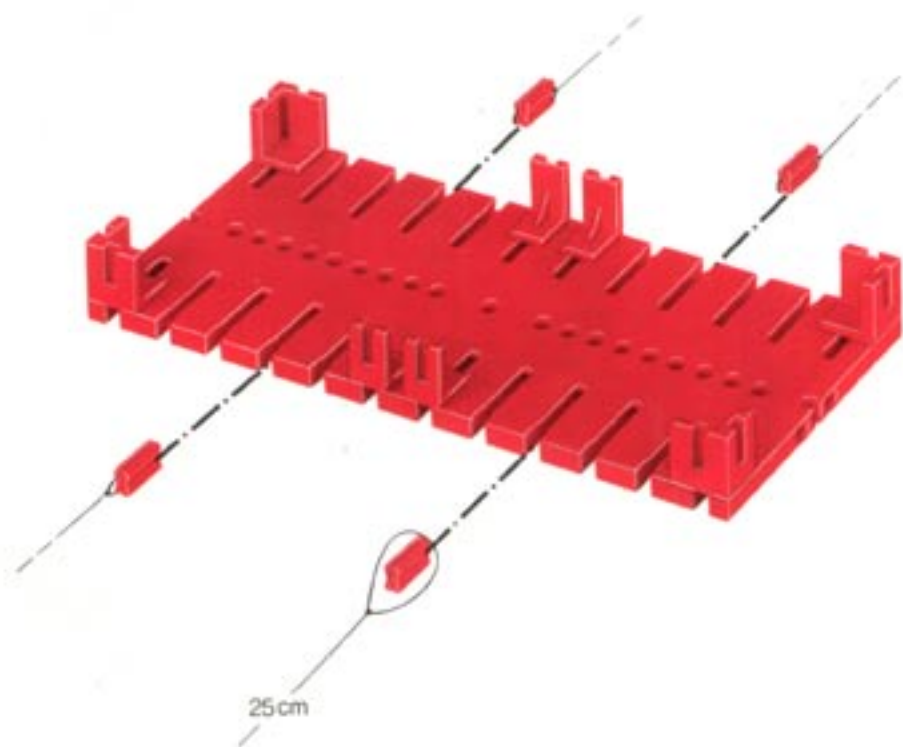

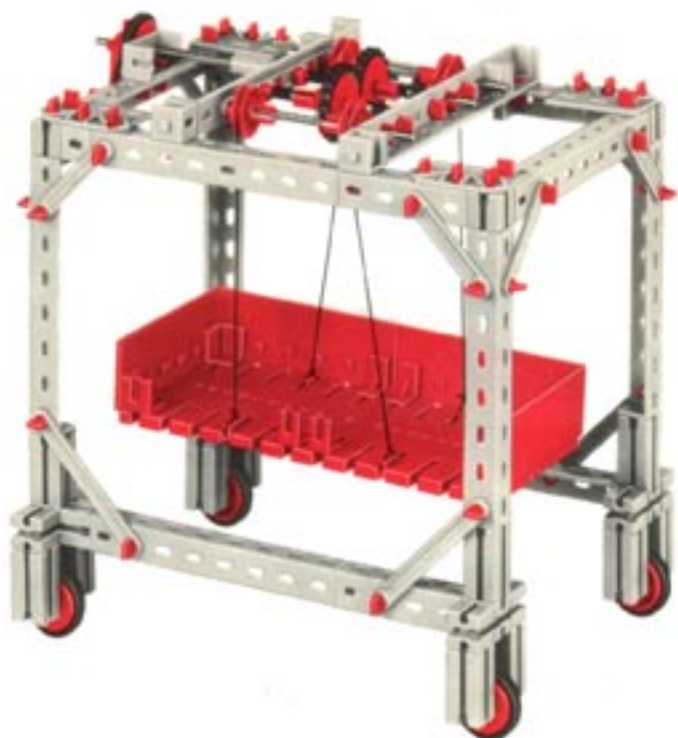

























Stückliste · Parts List · Nomenclature · Onderdelenlijst

	12	Winkelträger 120 · Angle girder 120 · Cornière de 120 · Hoekdraagsteun 120 4 36303 1		2	Lasche 15 · Connecting strip 15 · Éclisse de 15 · Rechtverbinding 15 4 36326 1
	4	Winkelträger 60 · Angle girder 60 · Cornière de 60 · Hoekdraagsteun 60 4 36302 1		2	Lasche 21,3 · Connecting strip 21,3 · Éclisse de 21,3 · Rechtverbinding 21,3 4 36327 1
	4	Winkelträger 30 · Angle girder 30 · Cornière de 30 · Hoekdraagsteun 30 4 36301 1		4	Doppelknotenplatte · Double gusset plate · Gousset · Dubbele hoekverbinding 4 35797 1
	2	Winkelträger 15 · Angle girder 15 · Cornière de 15 · Hoekdraagsteun 15 4 36300 1		70	S-Riegel 4 · Single rivet 4 mm · Rivet de 4 mm · S-grendel 4 mm 4 36323 1
	4	Winkelträger 15 mit 2 Zapfen · Angle girder 15 with two pins · Cornière de 15 à 2 tenons · Hoekdraagsteun 15 met 2 nokken 4 36304 1		15	S-Riegel 6 · Double rivet 6 mm · Rivet de 6 mm · S-grendel 6 mm 4 36324 1
	4	Scharnier · Hinge · Charnière · Scharnier 4 36329 1		4	S-Riegel 8 · Triple rivet 8 mm · Rivet de 8 mm · S-grendel 8 mm 4 36457 1
	12	Strebe 30 · I-strut 30 · Entretoise type I de 30 · I-spant 30 4 36309 1		15	Riegelscheibe · Locking washer · Disque d'arrêt · Grendelochijf 4 36334 1
	4	Strebe 45 · I-strut 45 · Entretoise type I de 45 · I-spant 45 4 36310 1		1	Nylonseil · Nylon cord · Filin Nylon · Nylon snoer 3 31027 1
	2	Strebe 45 mit Loch · I-strut 45 with holes · Entretoise type I à perf. mult. de 45 · I-spant 45 met gat 4 36536 1		1	S-Griff · Rivet holder · Tourne-rivet · S-greep 4 35800 1
	2	Strebe 60 mit Loch · I-strut 60 with holes · Entretoise type I à perf. mult. de 60 · I-spant 60 met gat 4 36535 1		1	Kassetten-Unterteil · Cassette, bottom · Coffret, partie inférieure · Cassette, onderstuk 4 35359 1
	12	Strebe 42,4 · X-strut 42,4 · Entretoise type X de 42,4 · X-spant 42,4 4 36315 1		1	Kassetten-Deckel · Cassette, top · Coffret, partie supérieure · Cassette, deksel 4 35360 1
	4	Strebe 63,6 · X-strut 63,6 · Entretoise type X de 63,6 · X-spant 63,6 4 36316 1			

